

YDP series

Max. Output: 3.5~7.4kW

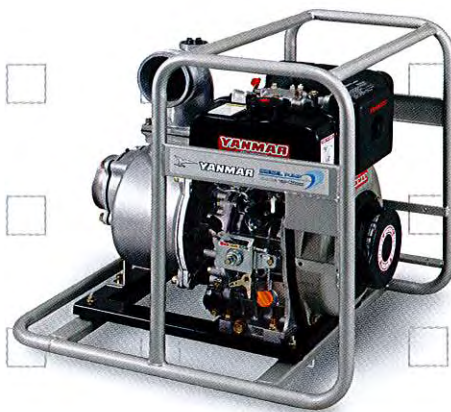

FRESH WATER PUMP



YDP20N YDP30N YDP40N

SEMI-TRASH PUMP



YDP20STN YDP30STN YDP40STN

TRASH PUMP



YDP20TN YDP30TN YDP40TN

DIAPHRAGM PUMP

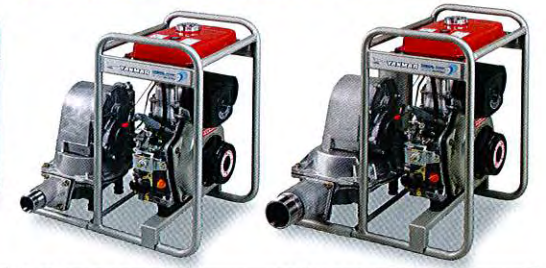

YDP20DN YDP30DN

FRESH WATER PUMP

- Light weight and compact design
- Easy maintenance: just remove the four bolts to clean the inside of the casing.
- Meets a wide range of applications coupled with air-cooled diesel engines.

Uses: Agriculture and home

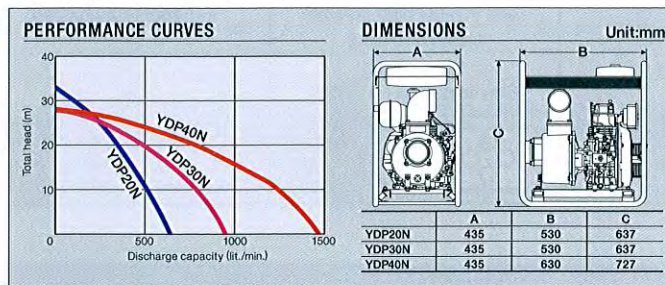

SEMI-TRASH PUMP

- Higher performance over standard fresh water pumps, unique to Yanmar.
- Handles gravel and trash below $\phi 20$ mm.
- Easy maintenance: just remove the four bolts to clean the inside of the casing.
- Sic ceramic mechanical seal can be used semi-permanently.

Uses: Agriculture, home, civil engineering, fishing

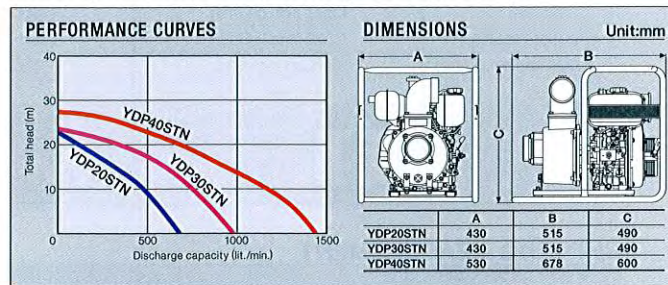

TRASH PUMP

- Handles water with $\phi 20$ -31mm gravel.
- Liner improves wear-resistance of the inner casing.
- Sic ceramic mechanical seal can be used semi-permanently.
- High chrome impeller with high durability.
- Pump can be cleaned easily by loosening the two grip bolts.

Uses: Civil engineering, rental

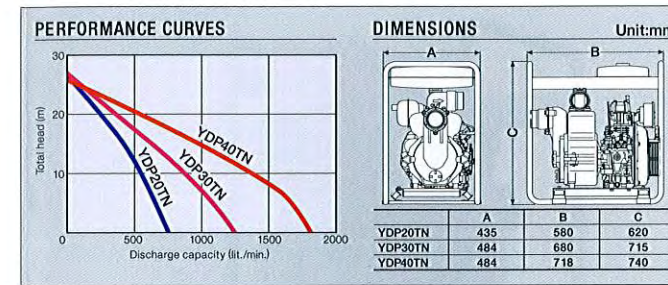

DIAPHRAGM PUMP

- Handles highly viscous fluid that centrifugal pumps can't pump.
- Capable of pumping water containing $\phi 25$ -31mm gravel and sludge.
- The reciprocation of the diaphragm efficiently transfers the fluid.

Uses: Civil engineering, cattle disposal treatment, aqua-culture

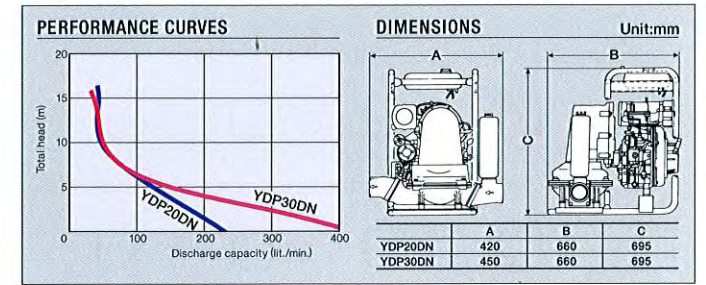

A wide option

Yanmar's pump series range in bore size from 2" to 4" for fresh water, semi-trash, trash, and diaphragm models. The series can handle all types of water, from fresh to muddy sludge.

Long running, fuel-thrifty diesels

Fuel-efficient diesel pumps can be operated 1.5-4 times longer than gasoline pumps. This advantage truly shows in night time and other continuous pumping operation at sites where no commercial power is available.

Durable construction

The principal parts of each pump are reinforced for superior wear resistance. The trash pumps are further strengthened by adding liners to the inner casings.



- Long operation with large capacity fuel oil tank



- Low noise with large capacity exhaust muffler



- Easy starting with recoil starter



- Low vibration with rubber mount

Easy maintenance

Cleaning the inside of the casing can be done simply by just removing a few bolts. With trash pumps, the casing cover and the inner casing come in one block, so separation and fitting is very easy.



	Fresh water pump		Semi-trash pump	Trash pump
	YDP20N, 30N	YDP40N		
No. of bolts	8	4	4	2
Bolt type	Hexagon bolt		Hexagon hole bolt	Handle knob
Tool	Common with engine		Standard accessory (hexagon wrench)	-

AIR-COOLED DIESEL ENGINE L-N SERIES

Its secret is Yanmar's micro-sized fuel injection system.

The fuel injection system, the heart of a diesel, has been refined through years of research and development at Yanmar. We have succeeded in minimizing the weight and size of this equipment and simplifying its structure by adoption of a bushless pump and a smaller nozzle.

- Durable — because it is built by a specialist in large diesel technology.
- Convenient Recoil starter — a feature commonly associated with gasoline engines.
- Fuel costs dip to a new low with Yanmar's direct fuel injection system.
- Very low vibration and quiet running make it ideal, a popular choice for constantly operating machinery.

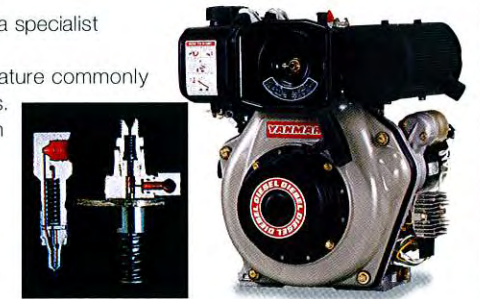

*Electric start available as option.

SPECIFICATIONS

Type	Fresh water pump			Semi-trash pump			Trash pump			Diaphragm pump			
	Model	YDP20N	YDP30N	YDP40N	YDP20STN	YDP30STN	YDP40STN	YDP20TN	YDP30TN	YDP40TN	YDP20DN	YDP30DN	
PUMP	Type	Self-priming pump			Self-priming pump			Self-priming pump			Compression pump		
	Suc. & discharge dia.	mm	50	80	100	50	80	100	50	80	50	80	
	Max. total head	m	32	28	26.5	22.5	23	25	24	27	25	15	
	Suction lift	m		7		7		7		7		7	
ENGINE	Max. capacity	lit./min.	550	900	1300	550	850	1300	550	1150	1750	190	320
	Model		L48NE		L70NE	L48NE		L70NE	L48NE	L70NE	L100NE	L48NE	
	Type		4-stroke, air cooled diesel engine			4-stroke, air cooled diesel engine			4-stroke, air cooled diesel engine			4-stroke, air cooled diesel engine	
	Displacement	cc	219		320	219		320	219	320	435	219	
UNIT	Max. output	kw/min ¹ (rpm)	3.5/3600		4.9/3600	3.5/3600		4.9/3600	3.5/3600	4.9/3600	6.6/3600	3.5/3600	
	Cont. output	kw/min ¹ (rpm)	3.1/3600		4.4/3600	3.1/3600		4.4/3600	3.1/3600	4.4/3600	6.6/3600	3.1/3600	
	Starting system		Recoil			Recoil			*Recoil			Recoil	
	Fuel oil tank capacity	lit.	5.5			2.4		3.3	5.5	12.5		5.5	
DIMENSIONS	Dimensions L×W×H	mm	530×435×637		630×435×727	515×430×490		678×530×600	580×435×620	680×484×715	718×484×740	660×420×695	660×450×695
	Dry weight	kg	40	42	59	39	40	56	56	72	109	53	60

		Fresh water	Semi-trash	Trash	Diaphragm	
Construction						
	Impeller					
Material (Principal parts)	Pump casing	Aluminum diecast (ADC12)	Aluminum diecast (ADC12)	Aluminum cast (AC2A)	2'AC2A/3'ADC12	
	Casing cover	Aluminum diecast (ADC12)	Aluminum diecast (ADC12)	Aluminum cast (AC2A)	2'AC2A/3'ADC12	
	Impeller	Cast iron (FC15)	Cast iron (FC20)	Cast iron (24 high chrome)	— (Diaphragm rubber)	
	Inner casing	Cast iron (FC15)	Cast iron (FC20)	Cast iron (FC30)	—	
	Mechanical seal	Carbon ceramic	Sic ceramic	Sic ceramic	—	
	Liner	—	—	Stainless steel (SUS430)	—	
Strainer Unit=in.		Pump size 1.5, 2.0 3.0, 4.0 Opening diameter φ6 φ7		Pump size 2.0, 3.0 4.0 Opening diameter φ20		Pump size 2.0 3.0 Opening diameter φ25 φ31

SHIPPING MEASUREMENT

Pump Series	Model	Packing Measurement			Volume m ³ (ft ³)	Weight: kg(lbs)		Q'ty/20ft Container
		Length: mm (in.)	Width: mm (in.)	Height: mm (in.)		Net	Gross	
Water	YDP20N	540 (21.26)	405 (15.94)	608 (23.94)	0.1330 (4.69)	40 (88)	44 (97)	168
	YDP30N	540 (21.26)	405 (15.94)	608 (23.94)	0.1330 (4.69)	42 (93)	46 (101)	168
	YDP40N	660 (25.98)	465 (18.31)	765 (30.12)	0.2348 (8.28)	59 (130)	63 (139)	96
Semi-trash	YDP20STN	555 (21.85)	475 (18.70)	540 (21.26)	0.1424 (5.02)	39 (86)	43 (95)	192
	YDP30STN	555 (21.85)	475 (18.70)	540 (21.26)	0.1424 (5.02)	40 (88)	44 (97)	192
	YDP40STN	708 (27.87)	560 (22.05)	640 (25.20)	0.2537 (8.95)	56 (123)	60 (132)	96
Trash	YDP20TN	620 (24.17)	480 (18.90)	660 (25.98)	0.1964 (6.93)	56 (123)	60 (132)	126
	YDP30TN	720 (28.35)	525 (20.67)	845 (33.27)	0.3194 (11.26)	72 (157)	76.5 (169)	70
	YDP40TN	760 (29.92)	525 (20.67)	870 (34.25)	0.3471 (12.25)	109 (240)	113.5 (250)	68
Diaphragm	YDP20DN	700 (27.56)	460 (18.11)	745 (29.33)	0.2399 (8.46)	53 (117)	56 (123)	120
	YDP30DN	700 (27.56)	490 (19.29)	745 (29.33)	0.2555 (9.01)	60 (132)	64 (141)	108

STANDARD ACCESSORIES

Pump Type	Fresh water	Semi-trash	Trash	Diaphragm
Strainer (slot-in type)	○	○	○	○
Hose coupling set	○	○	○	—
Hose band	○	○	○	—
Battery box	—	*	—	—
Battery cable	—	—	—	—
Tools	○	○	○	○

*YDP40STN and YDP40TN with Electric Start only.
The Battery and cable types differ depending on sales area.

NPT inside thread strainer	Slot-in type strainer	Hose coupling set	Hose band

OPTIONAL PARTS

Parts	Model	YDP30TN	YDP40STN
Wheel set		○	—

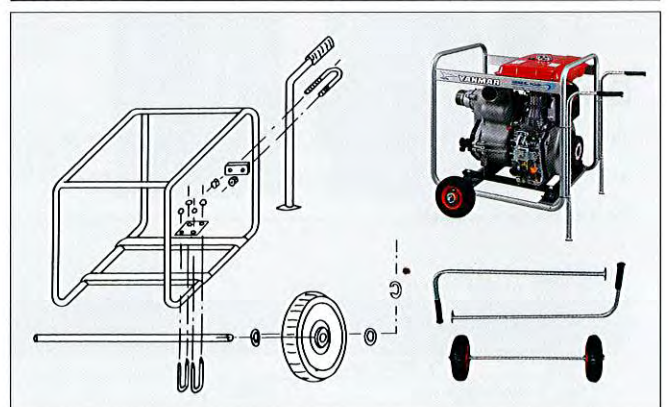

Note : All data subject to alteration without notice.

YANMAR CO.,LTD.

1-32, Chayamachi, Kita-ku, Osaka 530-8311, Japan
Telephone:+81-6-6376-6411 Facsimile:+81-6-6377-1243
www.yanmar.co.jp/en/